

Standard Colour Options

The GSF70 is available in a range of finishes.



Cross Sections

Track and trolley cross sections.

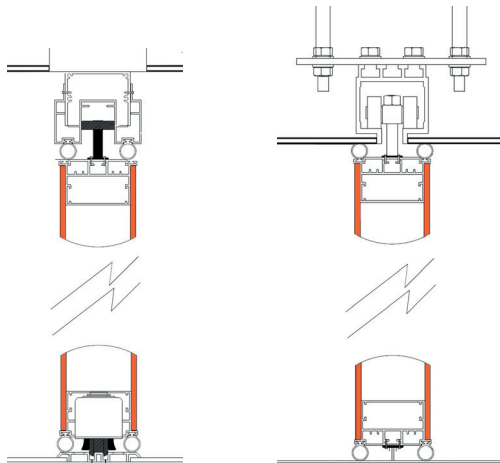

Stacking Arrangement Examples

The GSF70 integrates well into any environment.

SINGLE WING - CENTRE FOLDING

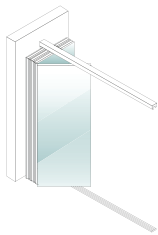

SINGLE WING - END FOLDING

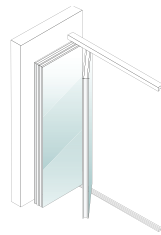

BI-PARTING - CENTRE FOLDING

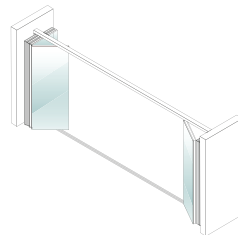

BI-PARTING - END FOLDING

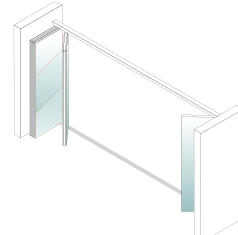

Panel Options

Get the most out of your space with panel and door options.

HALF PANEL

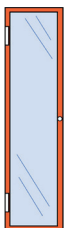

BASIC PANEL

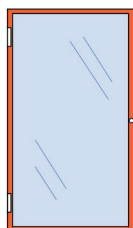

FULL HEIGHT PASS DOOR

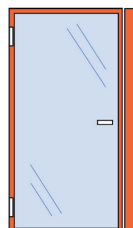

DOUBLE PASS DOOR

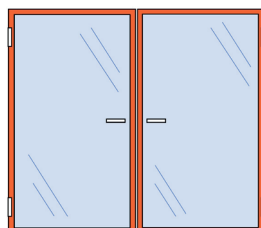

PASS DOOR OPTIONS